

4.2

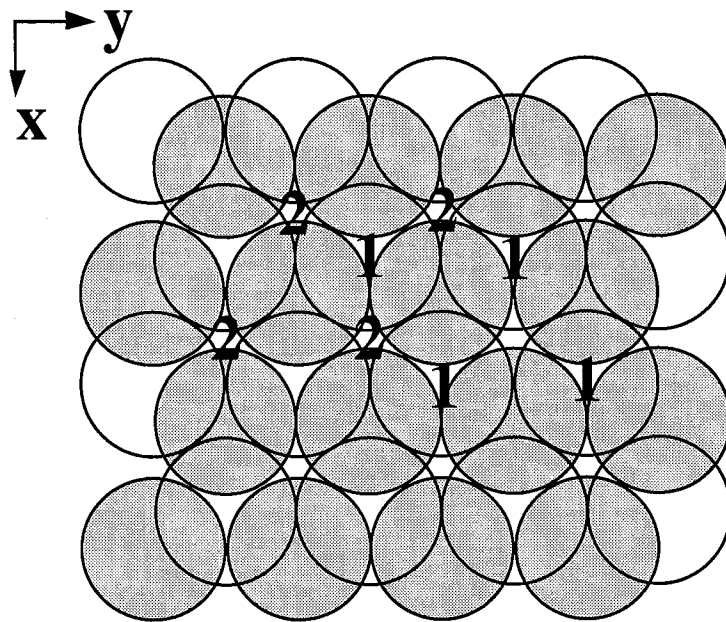

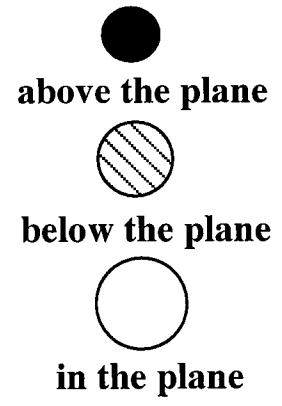

4,4

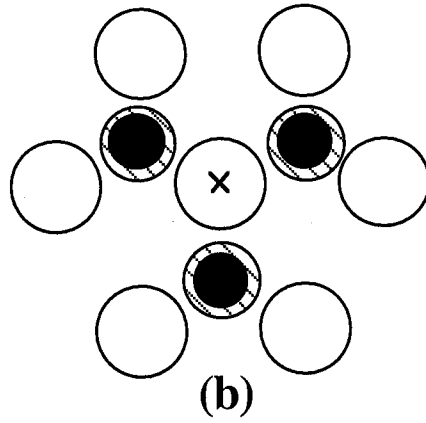
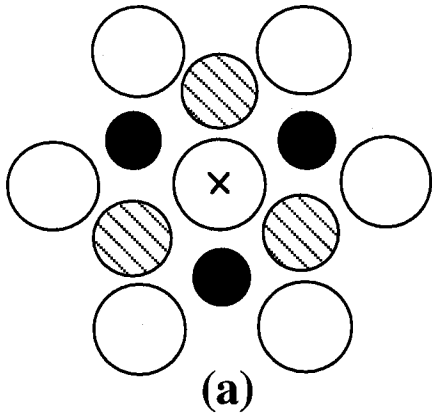
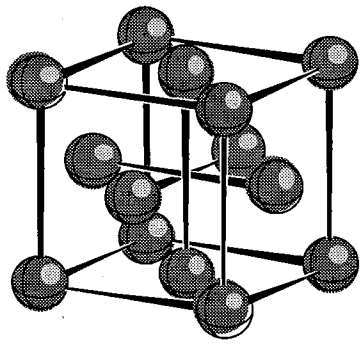

(a)

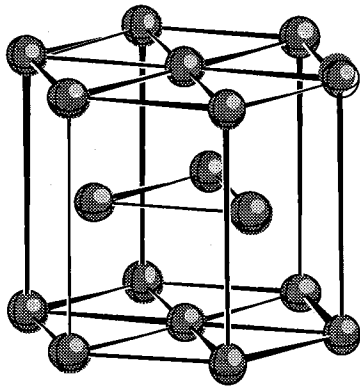
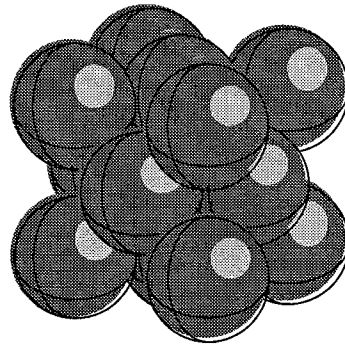

(b)

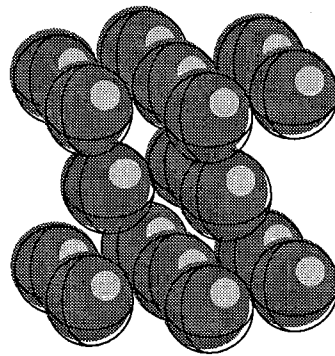

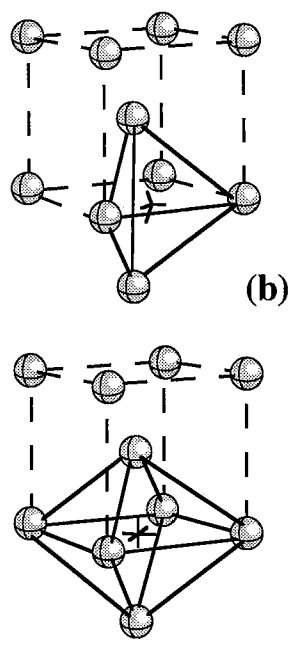
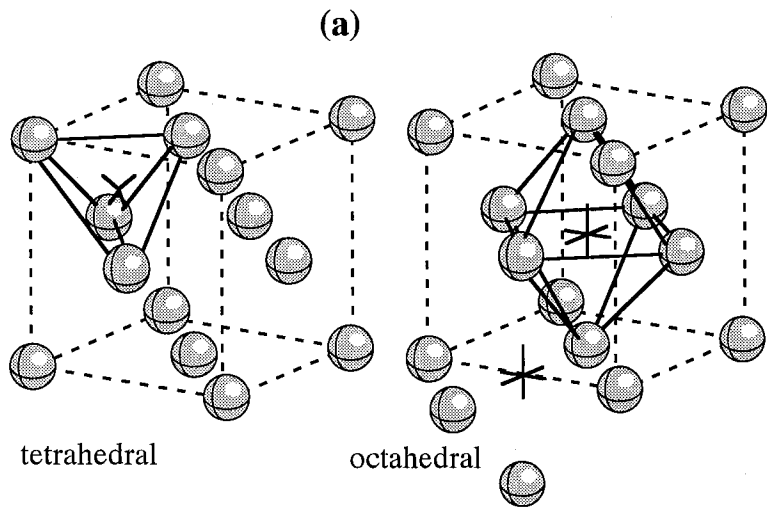

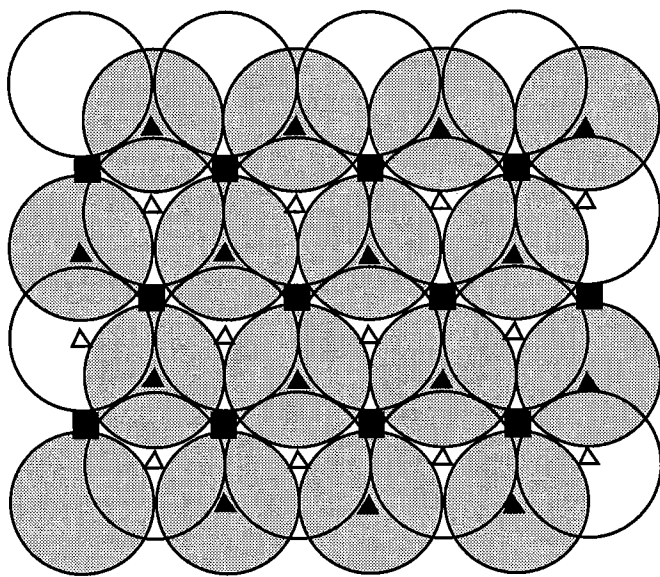
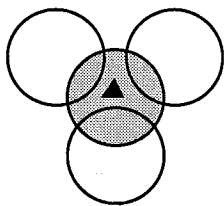
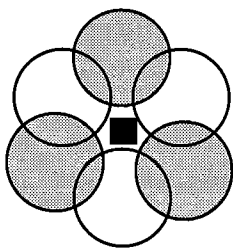
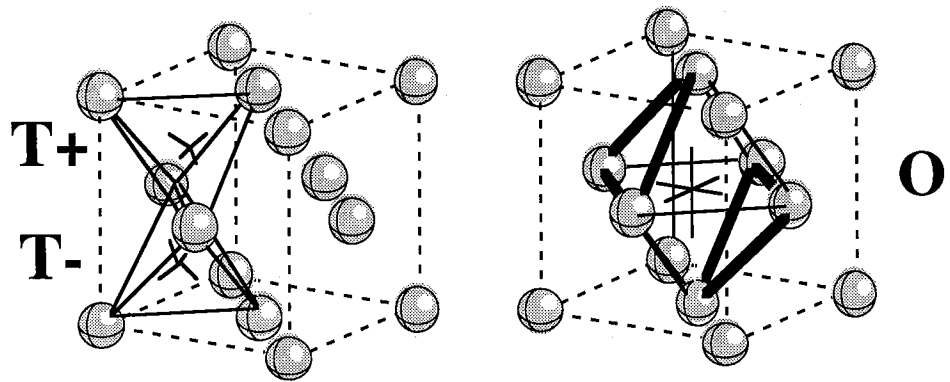

▲ $T-$ △ $T+$ ■ O

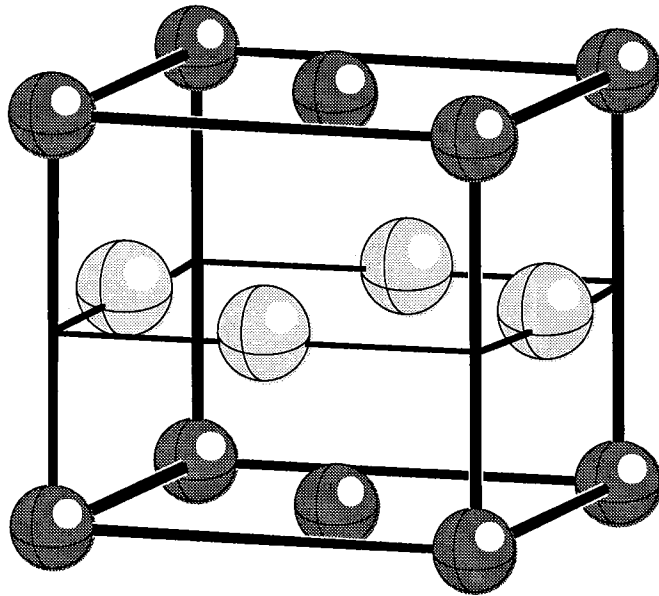
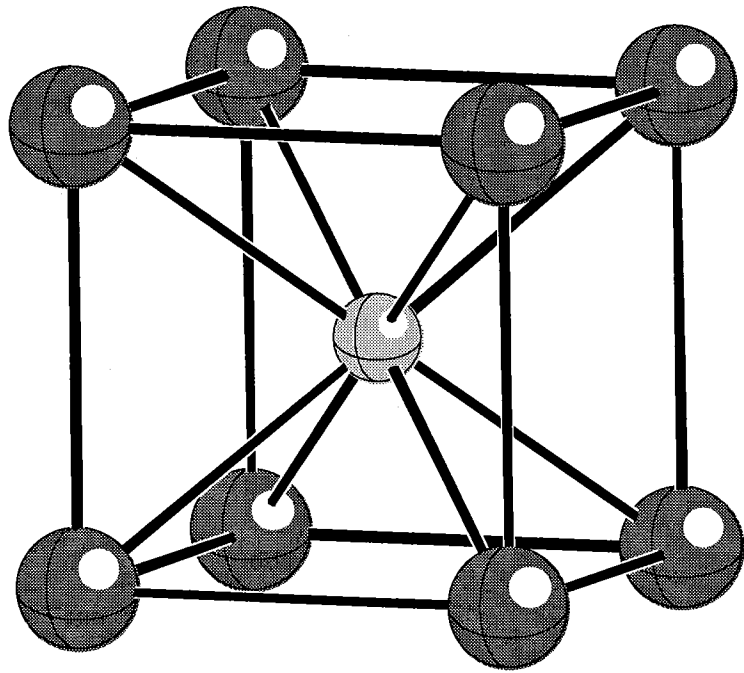

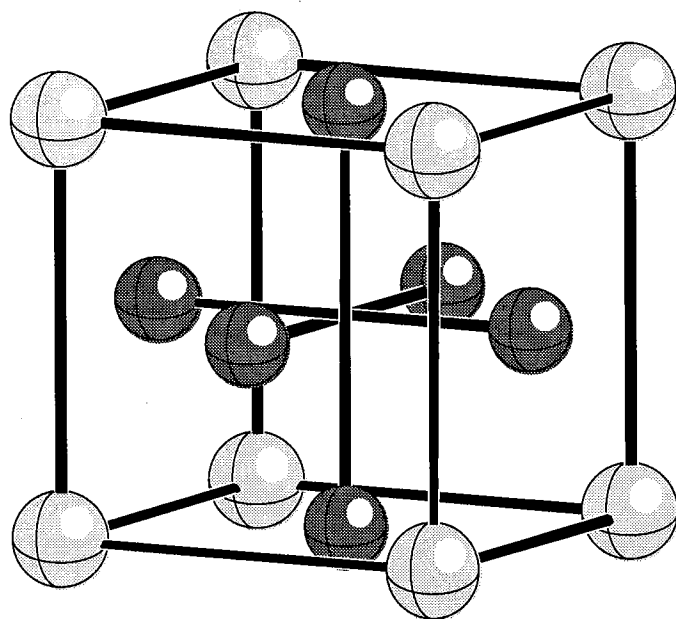

4.7

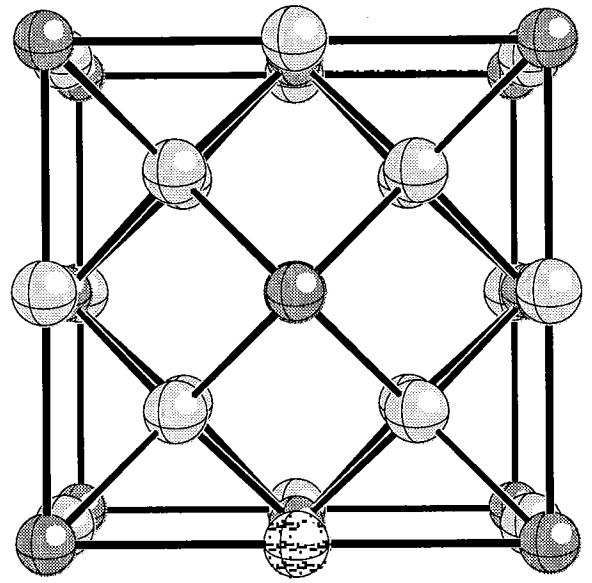
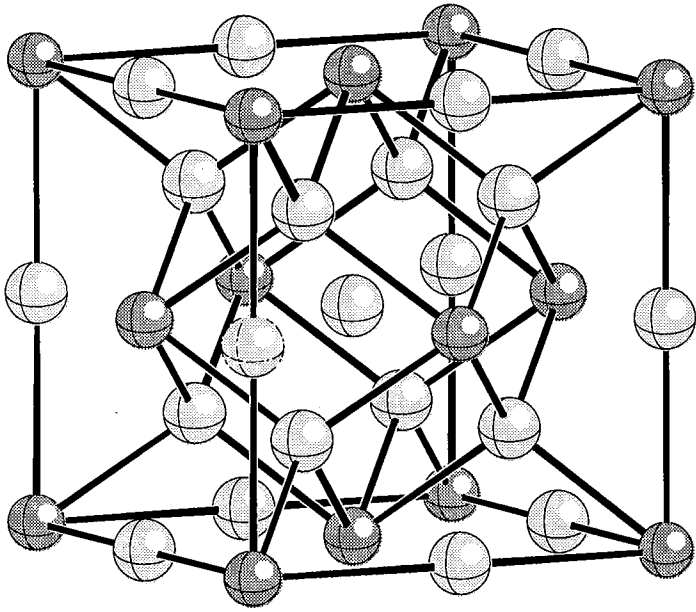

4, 10

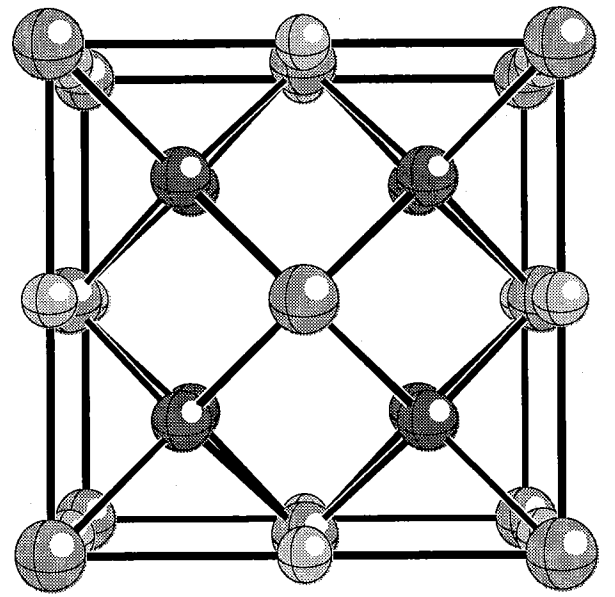
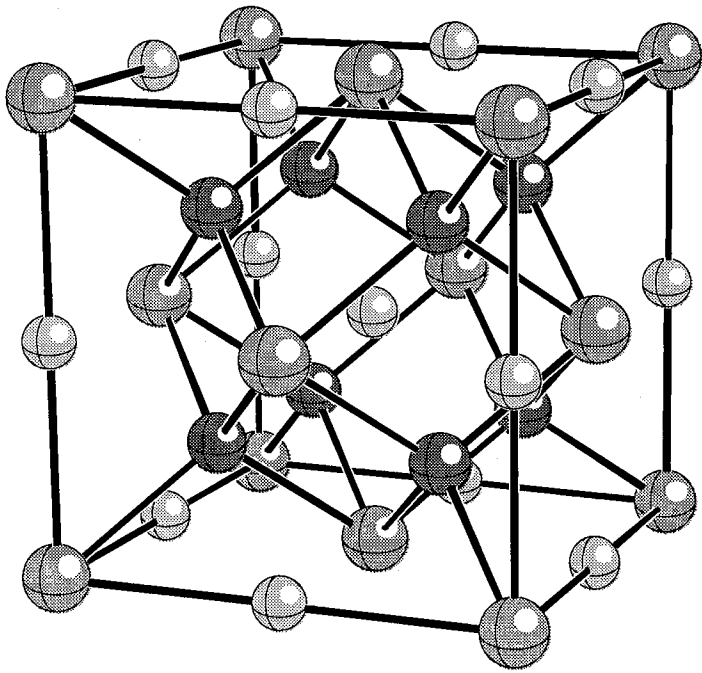

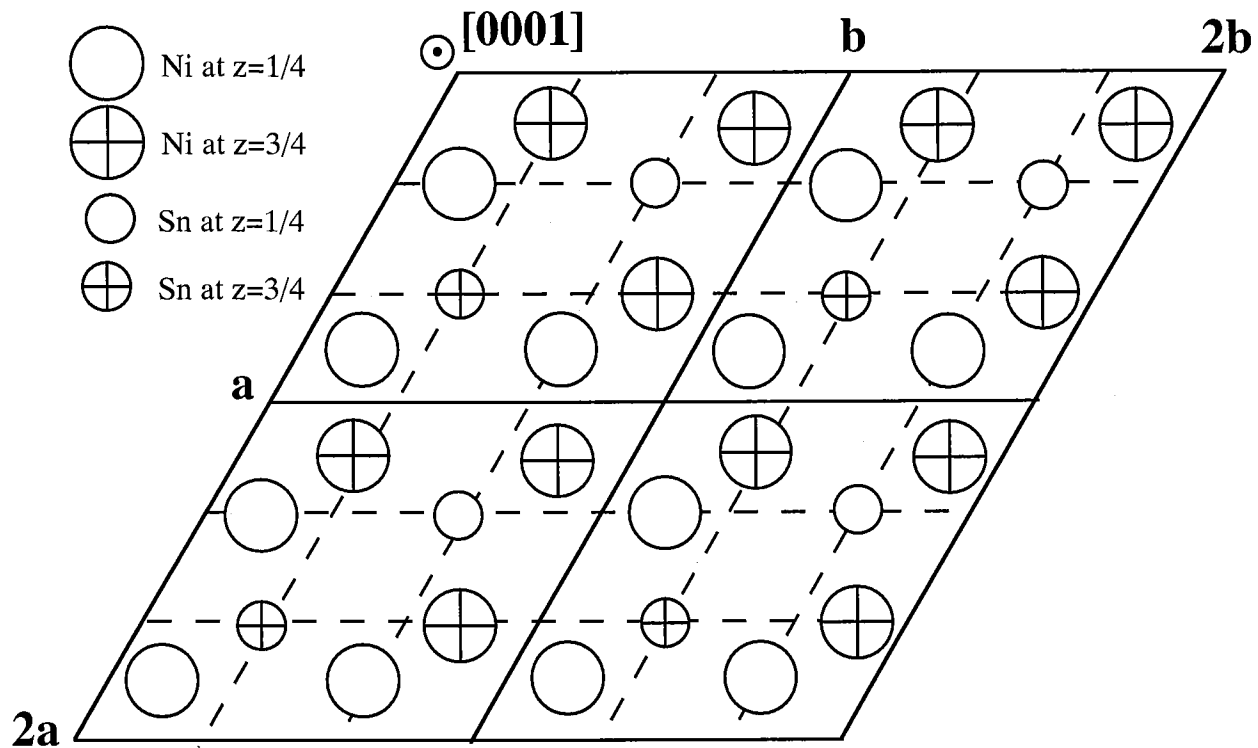

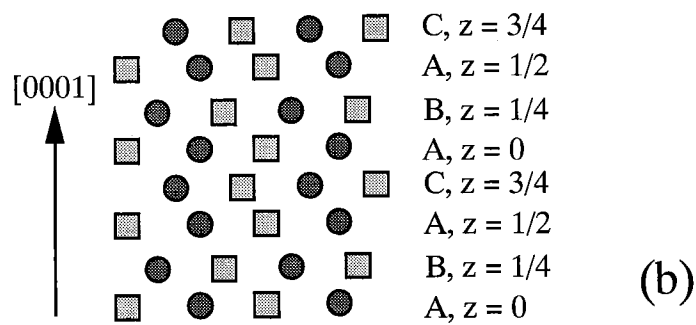
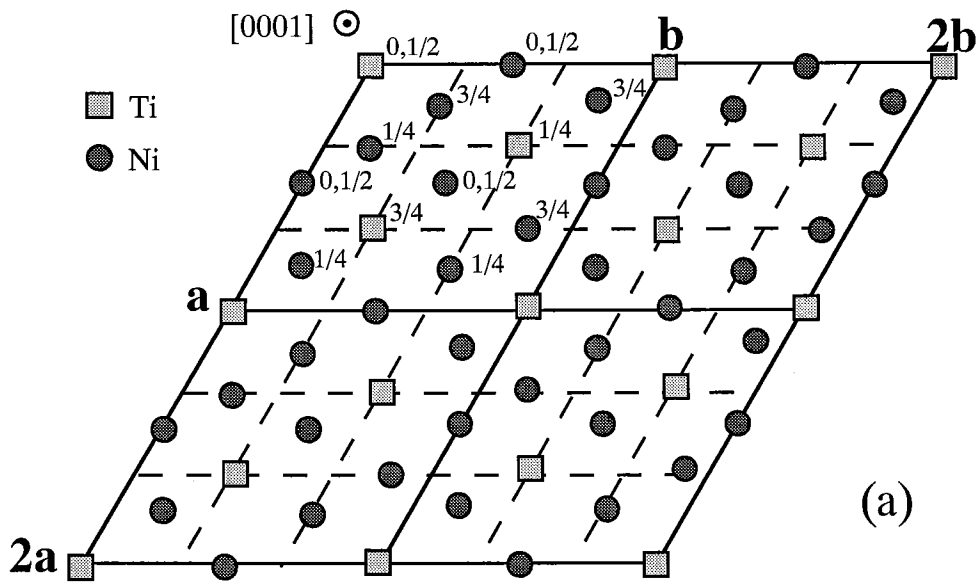

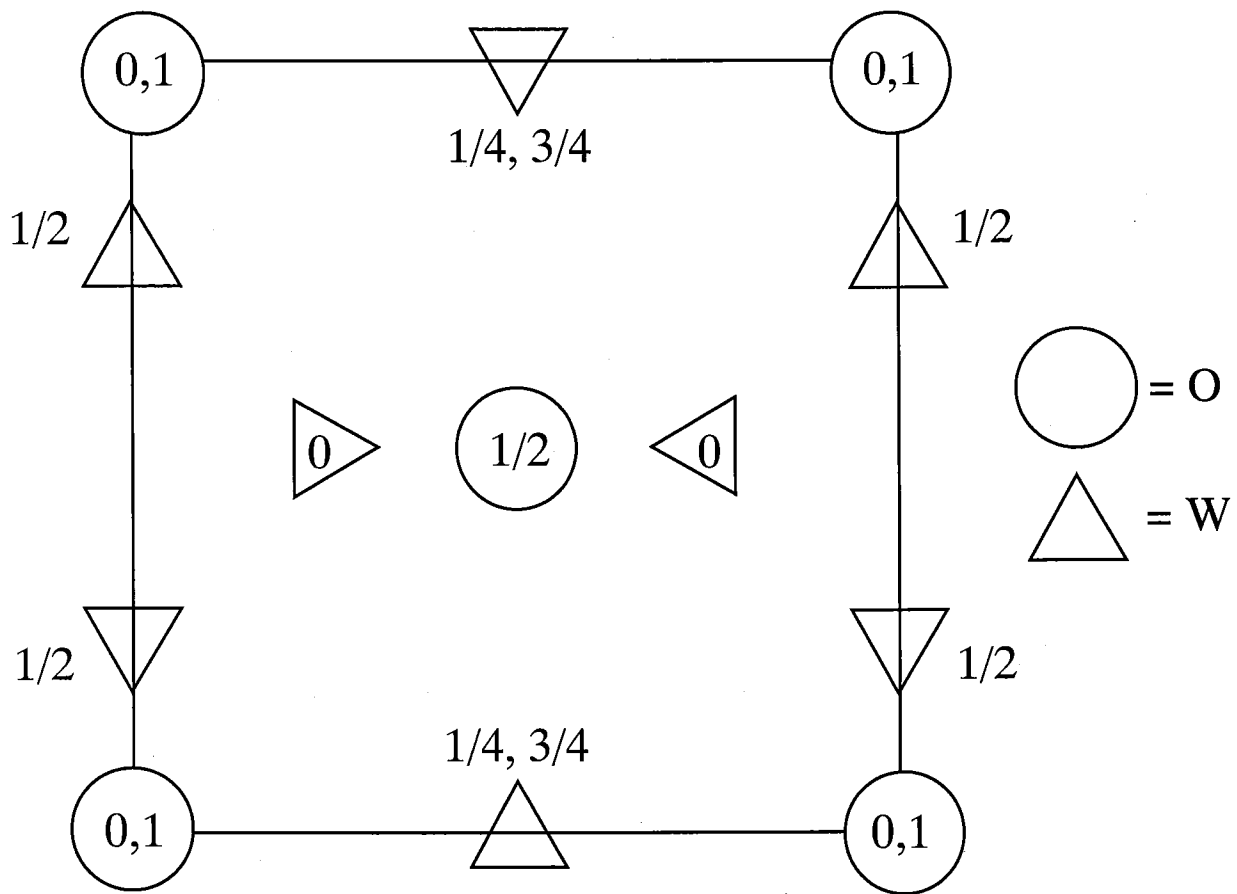

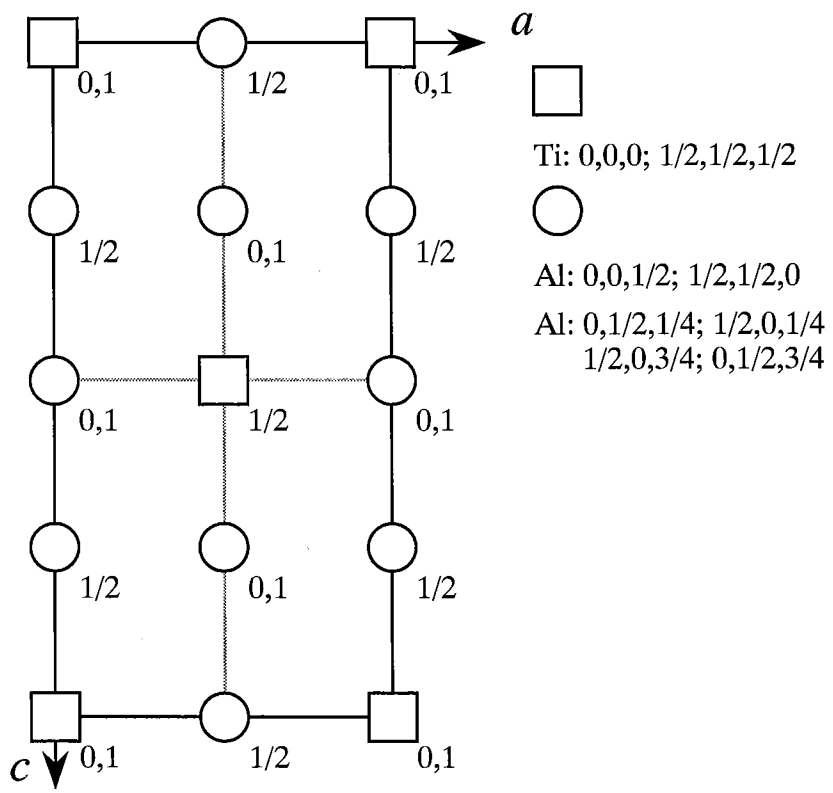

2.15

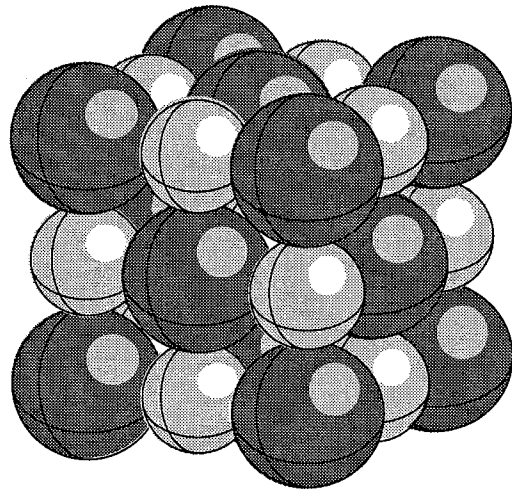
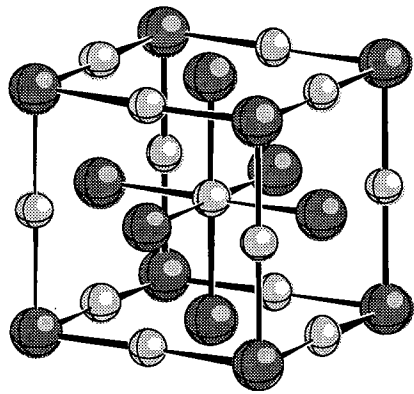

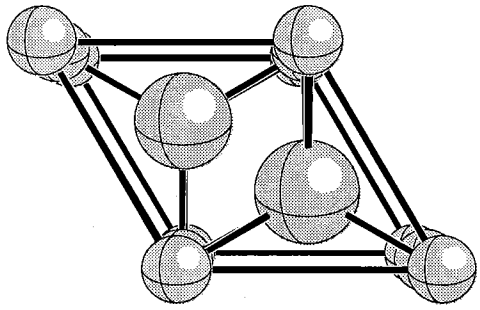

(a)

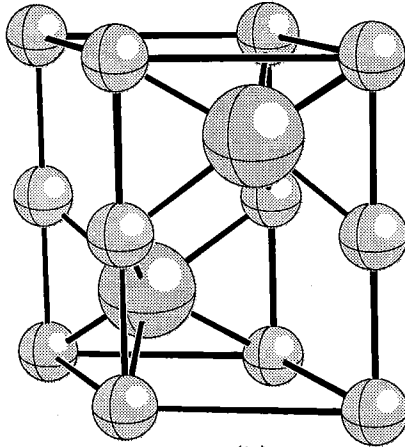

(b)

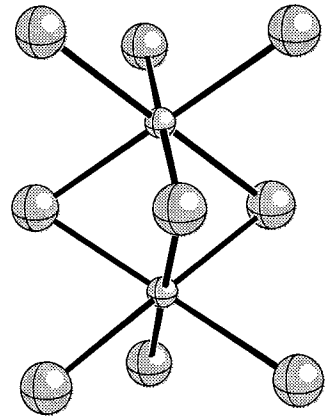

(c)

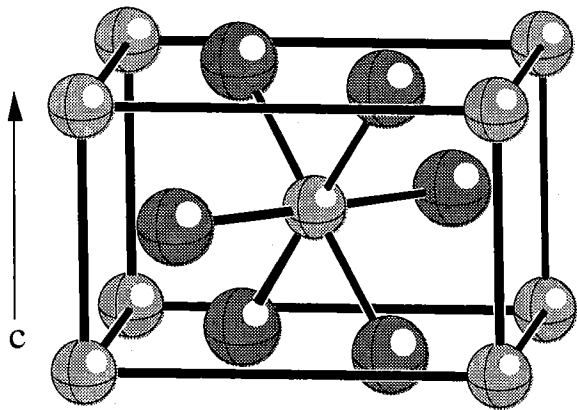

(a)

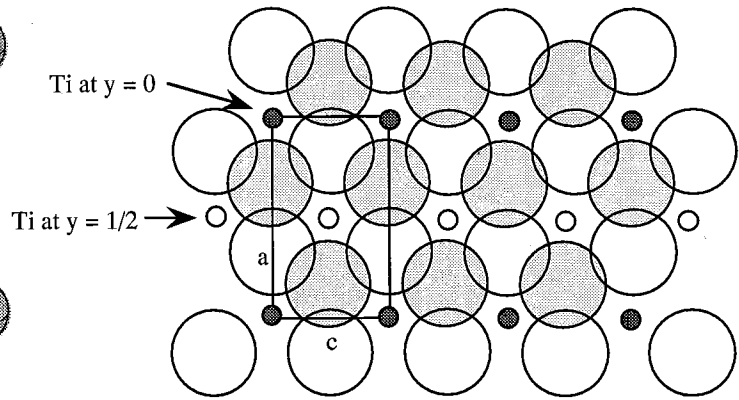

(b)

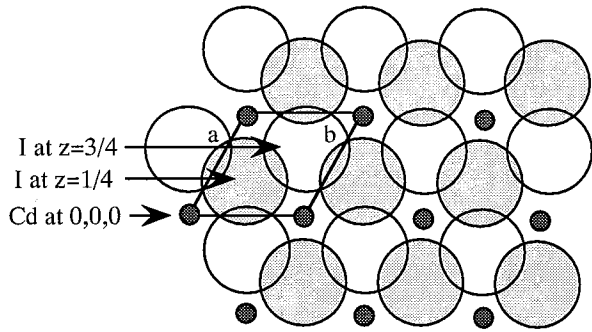

(a)

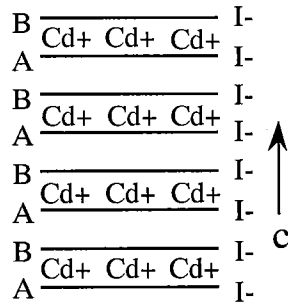

(b)

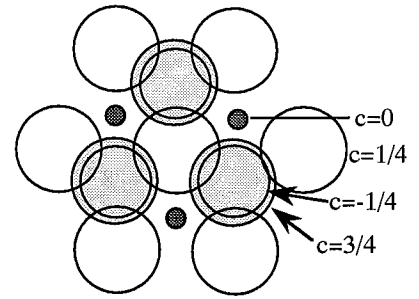

(c)

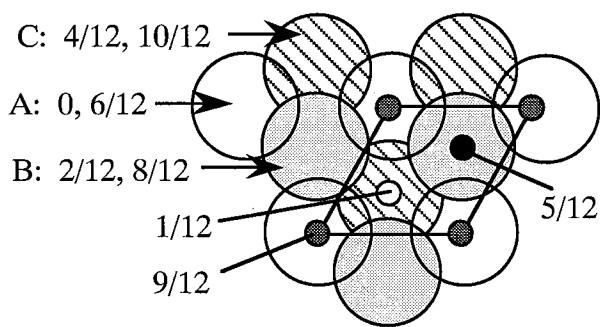

(a)

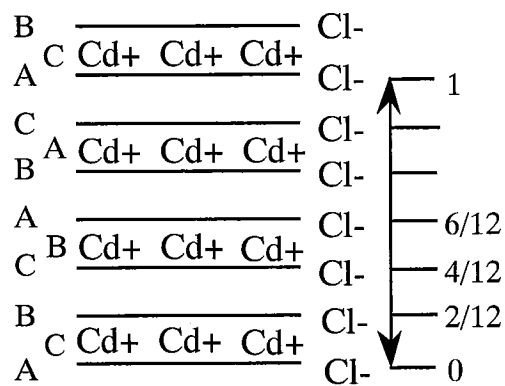

(b)

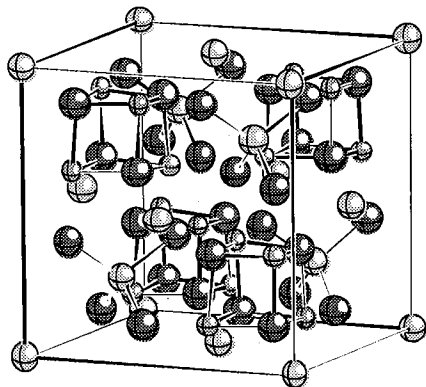

(a)

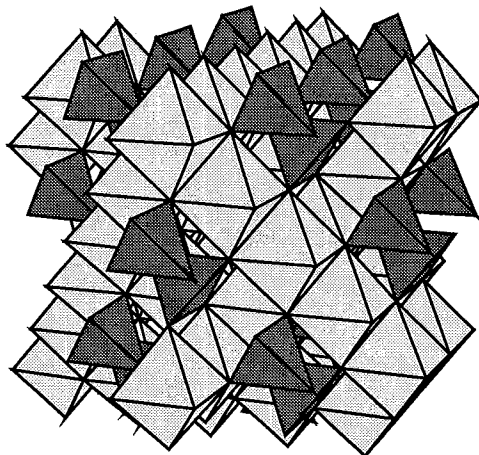

(b)

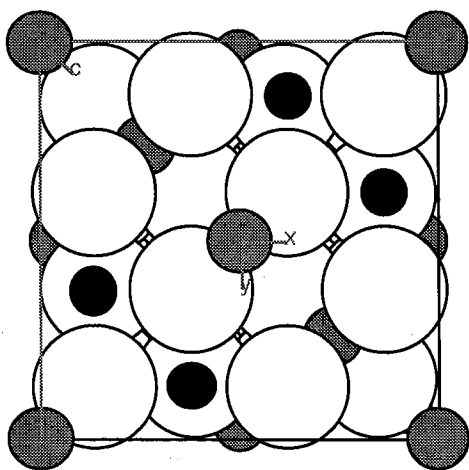

(c)

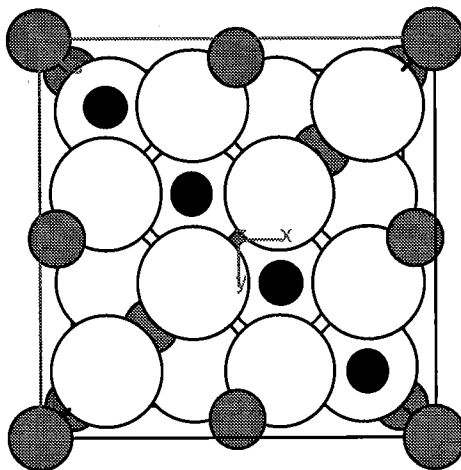

(d)

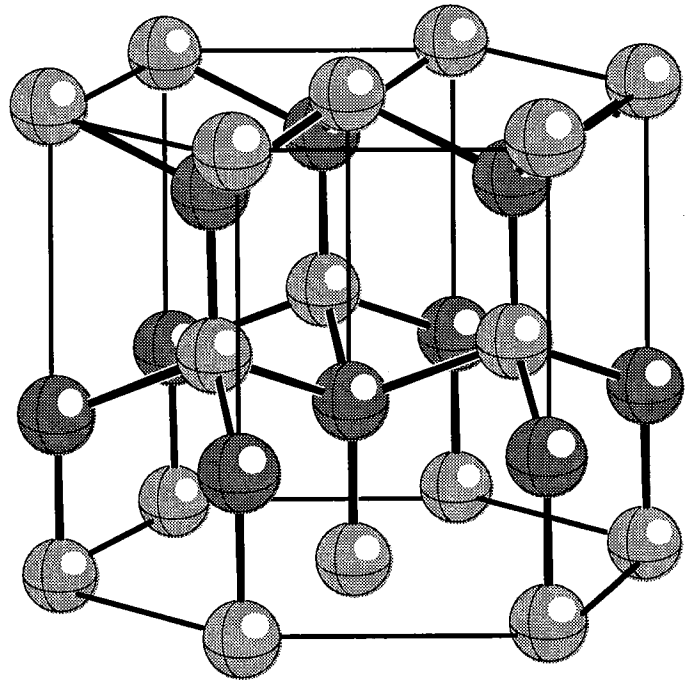
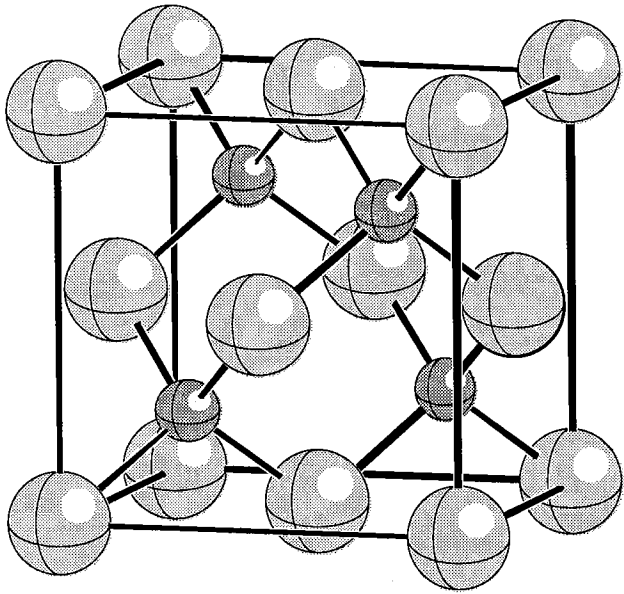

Handwritten signature or mark at the bottom left of the page.

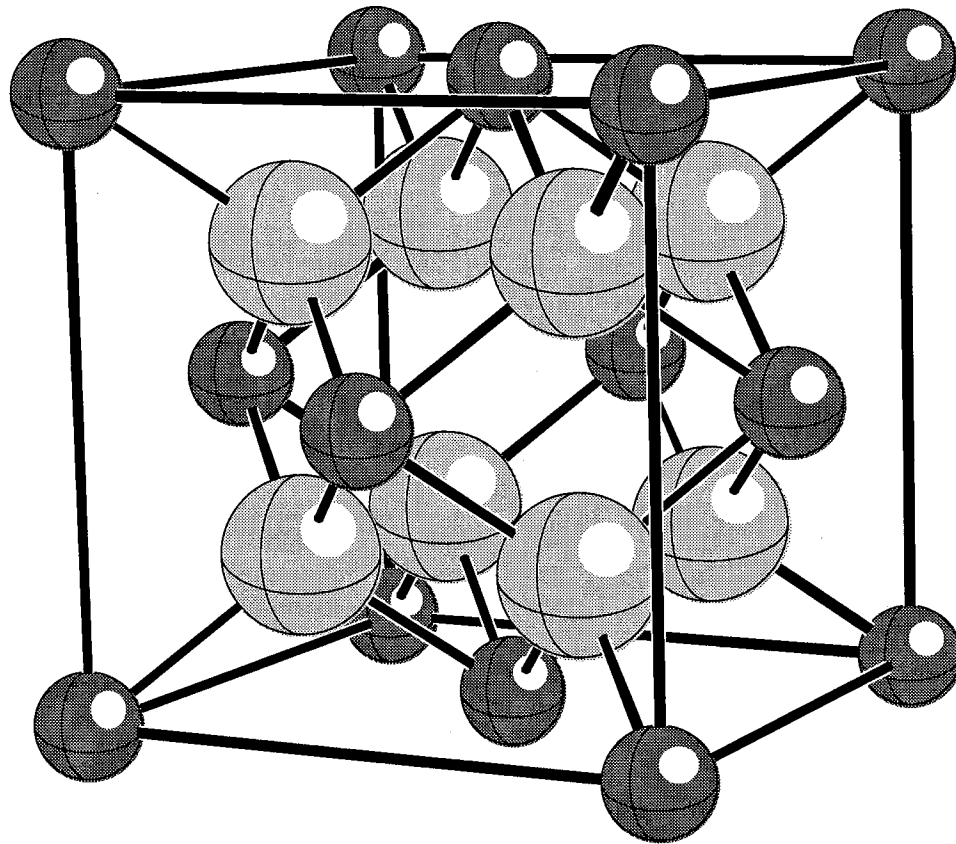

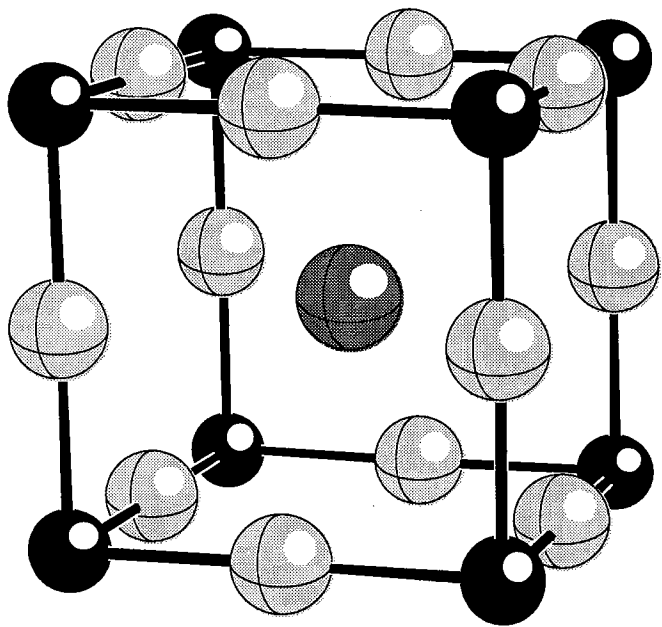

(a)

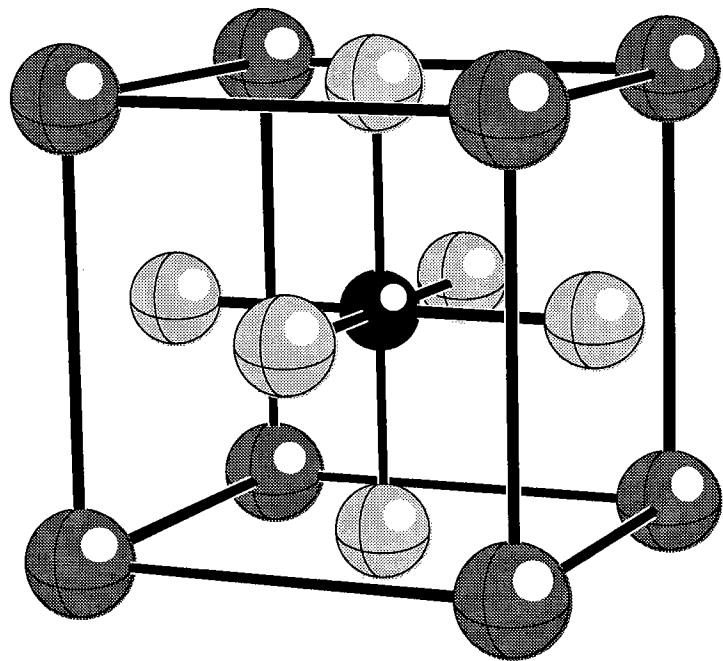

(b)

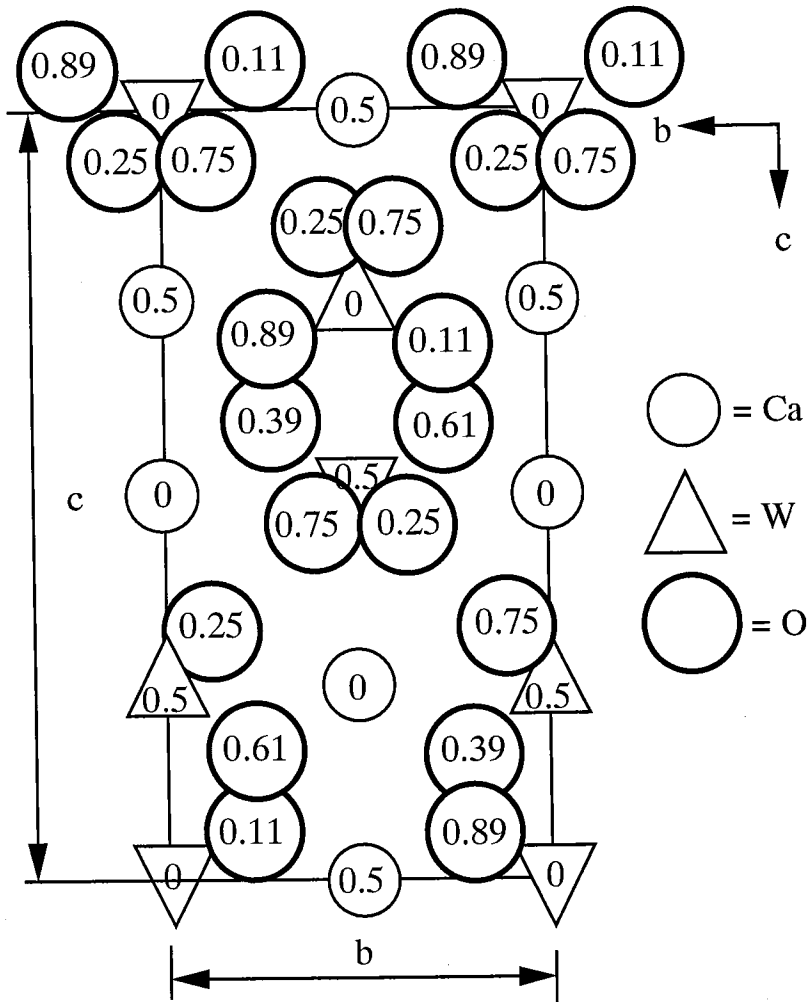

4.25

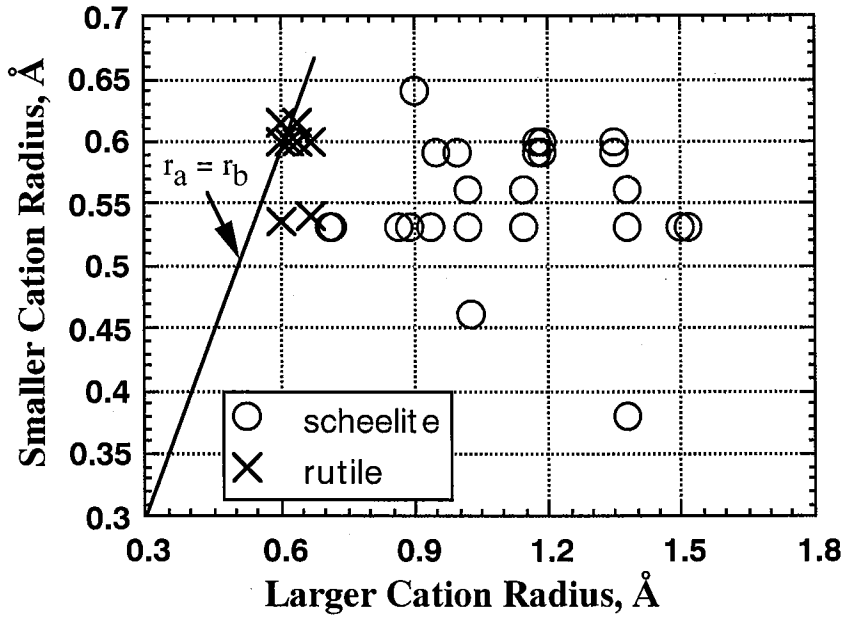

U. J. Co

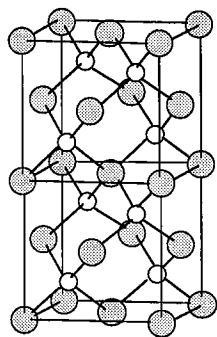

Spalrite, B3
ZnS

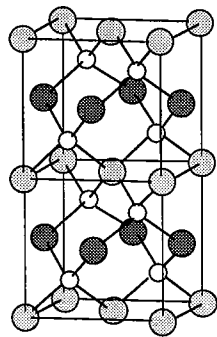

layered tetragonal, L1₀
InGaAs₂

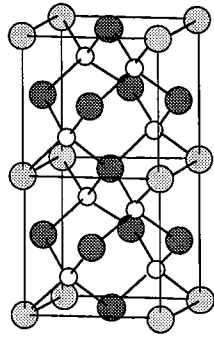

Luzonite, H2₄
Cu₃AsS₄

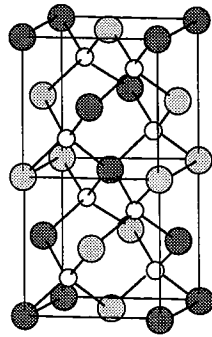

Chalcopyrite, E1₁
CuFeS₂

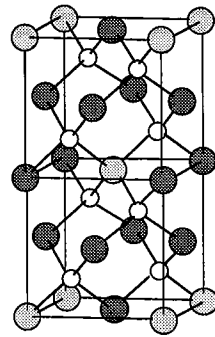

Femailite, H2_a
Cu₃SbS₄

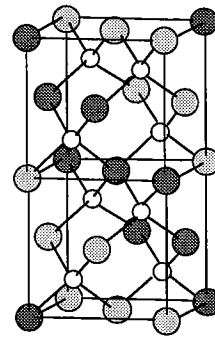

layered tetragonal, L1₁
(CrCuS₂) NaVS₂

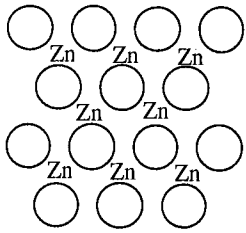

ZnO

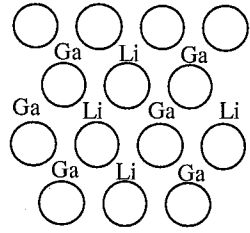

β -LiGaO₂

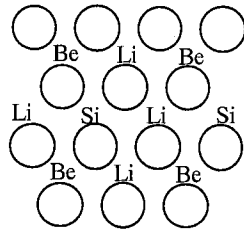

β -Li₂BeSiO₄

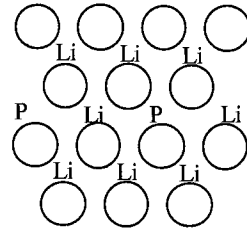

β II -Li₃PO₄

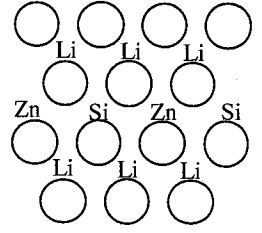

β II - Li₃ZnSiO₄

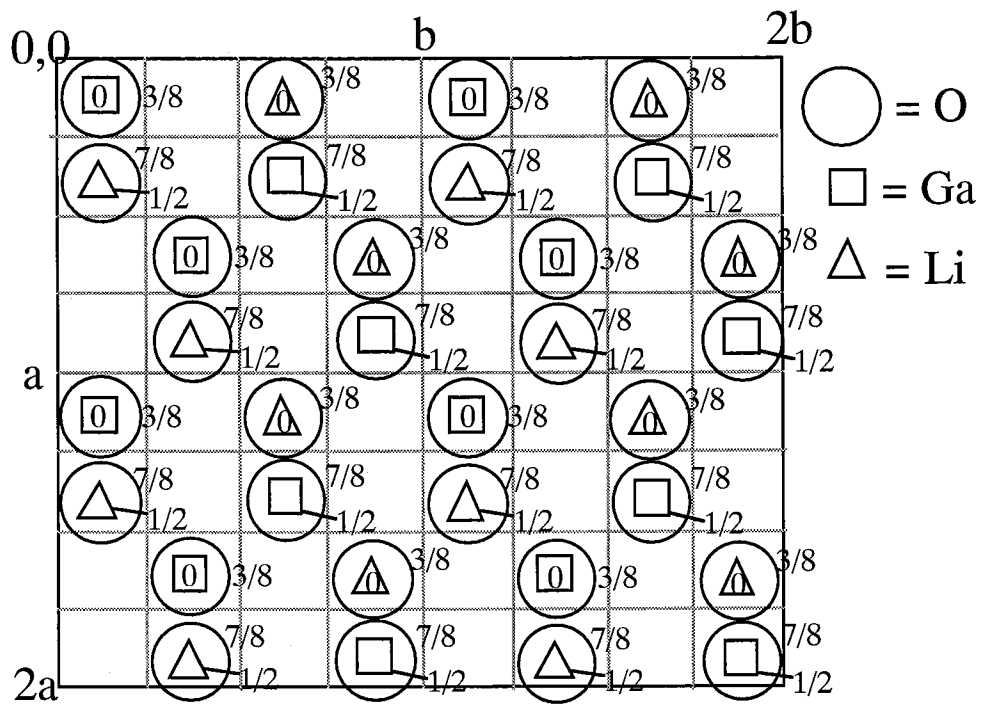

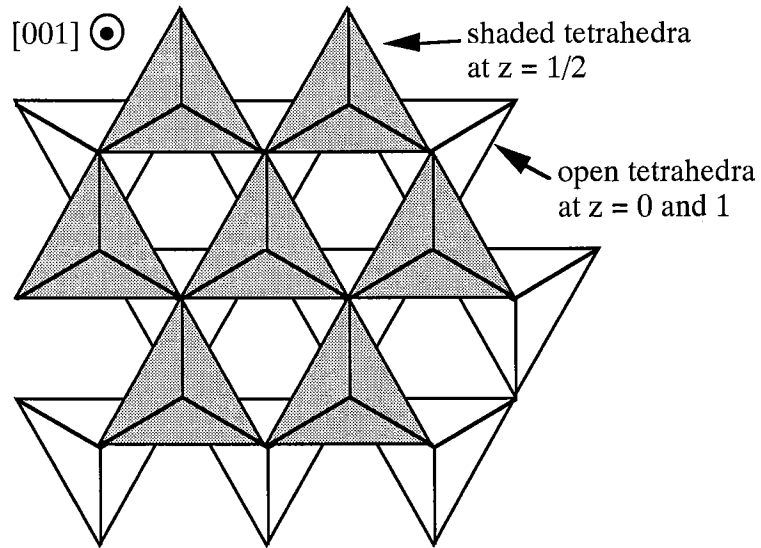

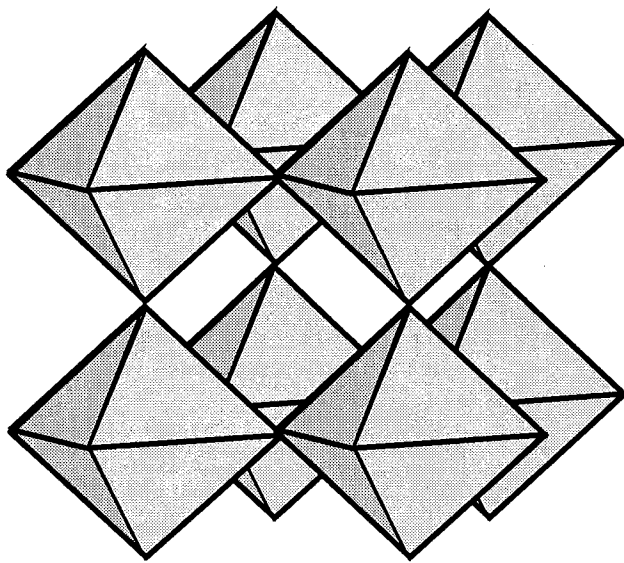

(a)

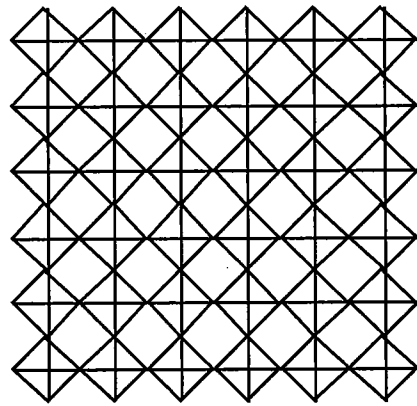

(b)

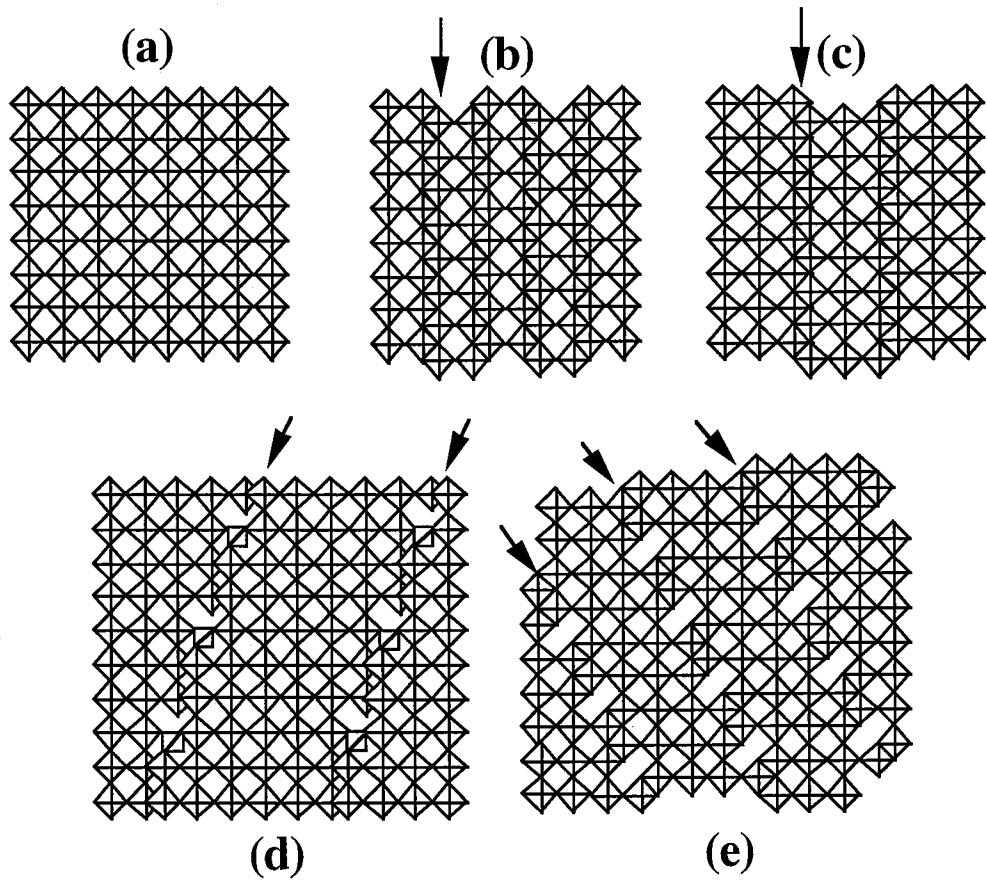

4.22

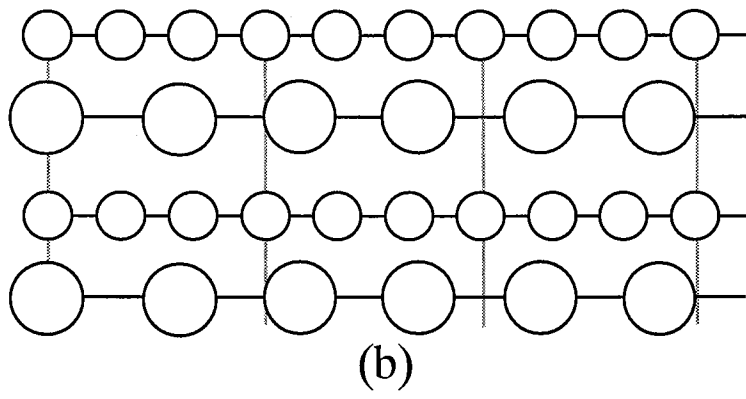
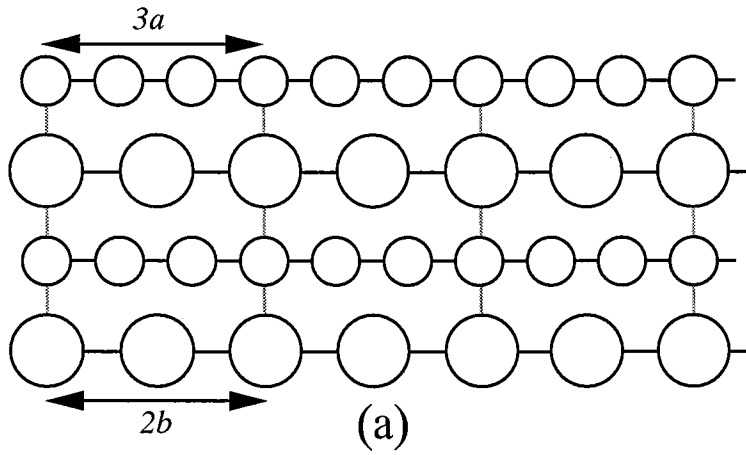

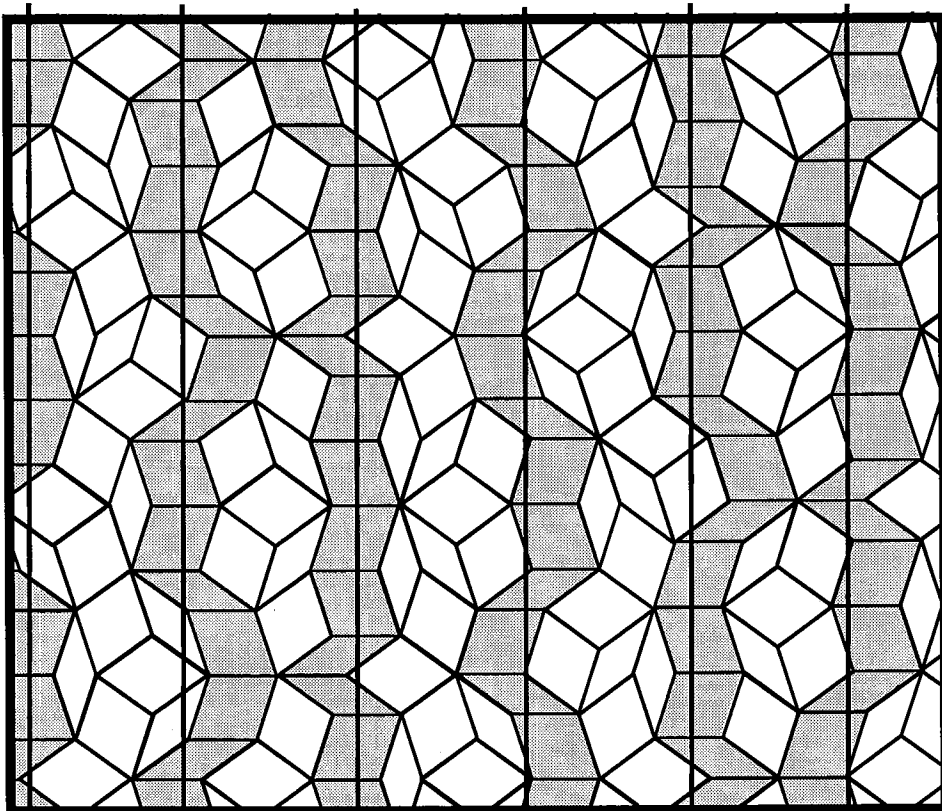
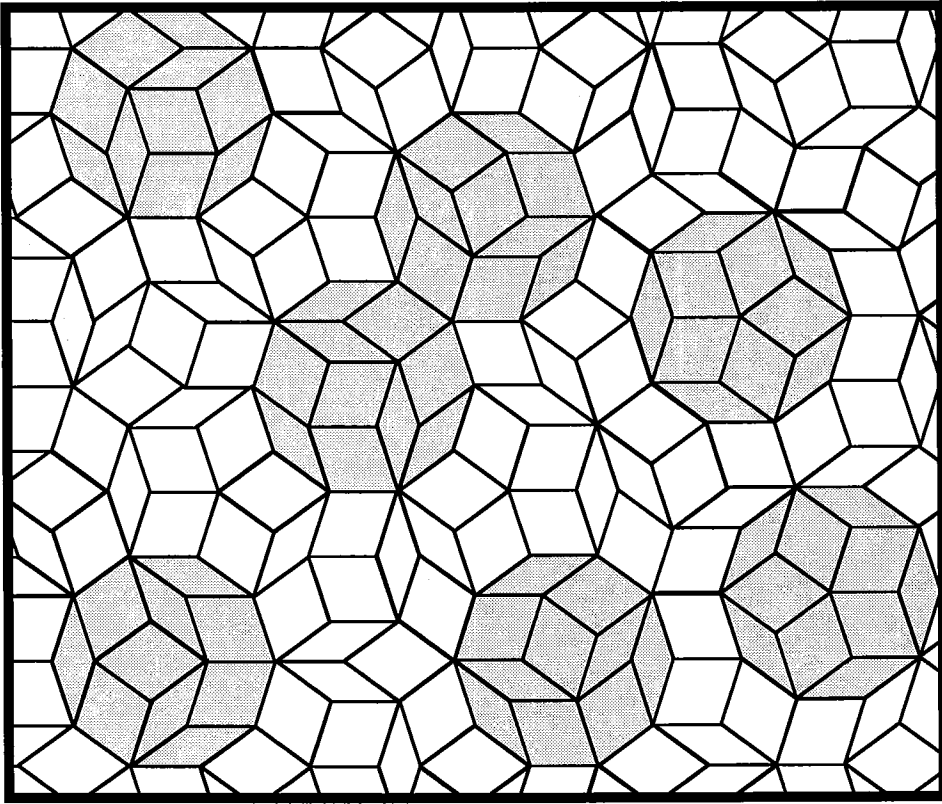

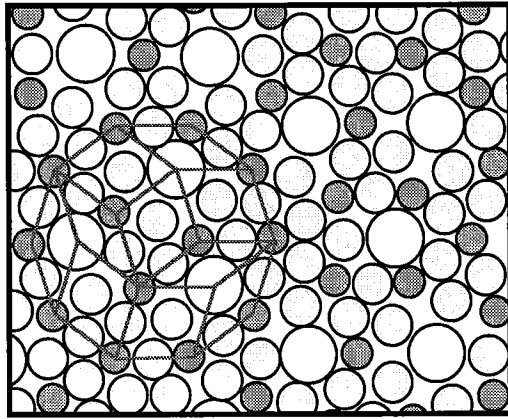

4.30

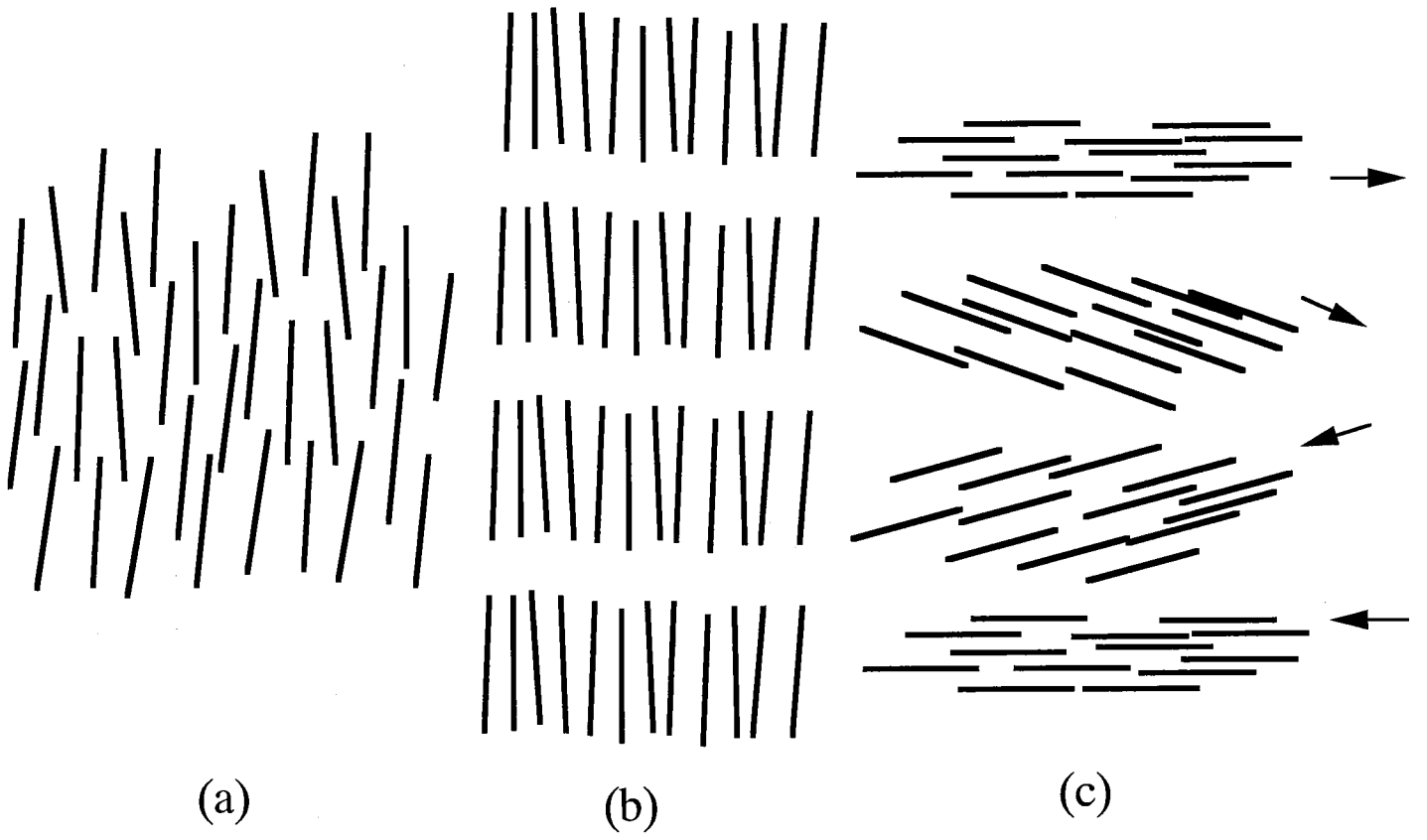

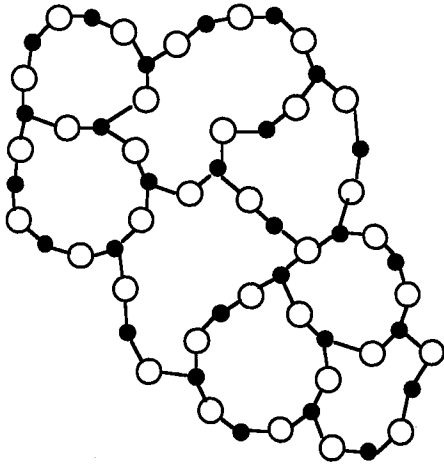

(a)

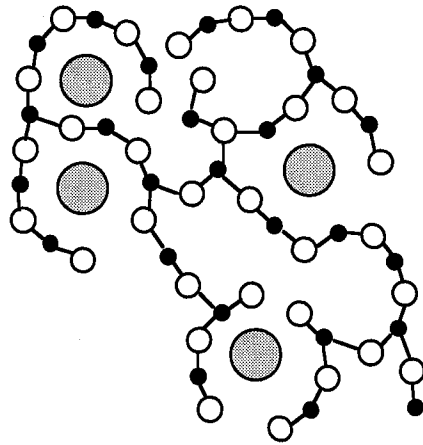

(b)

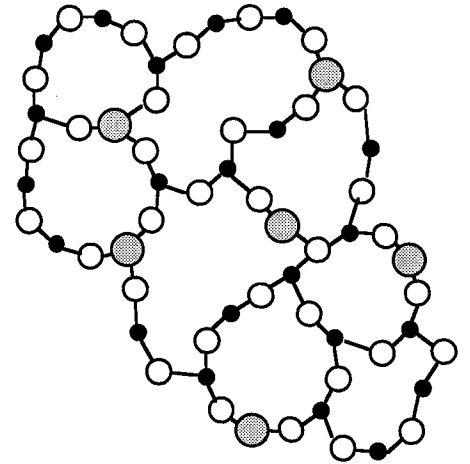

(c)